

**BESTORQ**<sup>®</sup>  
POWER TRANSMISSION PRODUCTS

## V-Belt Installation & Maintenance

February 2013

## proper v-belt installation

### 1. MAKE SURE PULLEYS ARE CLEAN

Check pulleys for rust, oil, grease, dust, dirt and other foreign materials. Clean the pulley. Foreign materials accelerate belt wear and decrease belt life. Dirt in the pulley grooves can impair traction.

Oil and grease impair traction and can destroy the belt surface.



### 2. INSPECT SHEAVE GROOVES

Check to make sure that no pulley grooves show excess wear. V-Belts should ride at least flush with the top of the pulley and may ride out of the pulley up to 0.1". Check for burrs, nicks, gouges, severe scratches and other major pulley surface issues. Any of these can cause severe decrease in belt life.

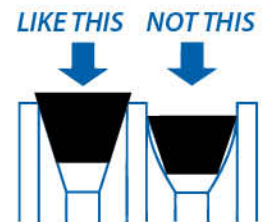

### 3. CHECK ALIGNMENT

Proper pulley and shaft alignment is critical for long belt life. As a rule of thumb, pulley misalignment should be no more than 0.1" in 10". Pulleys and shafts must be checked for Angular Misalignment and/or Axial Misalignment.

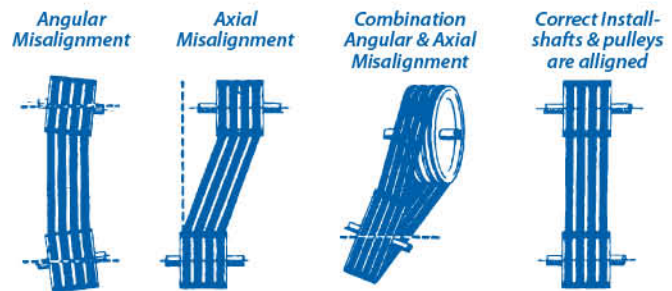

### 4. CORRECT ALIGNMENT

Use a straight edge to check for alignment. Make sure all four points of the straight edge contact the pulley. Position the straight edge in different ways to check for Axial and Angular misalignment. In multiple groove drives misalignment can cause belts that are actually

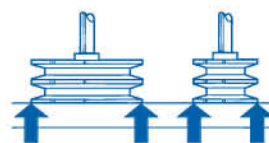

all the same length to appear different lengths. Misalignment causes severe belt wear, rollover and short belt life.



## 5. NEVER MIX BELTS

Never mix brands of belts. Never mix type of belts. (Such as raw edge or cogged or wrapped belts). Never mix used belts with new belts. The new belt or belts will carry all the load. Never mix used belts from two different drives. All mixed belts will cause the load to be carried unevenly by the belts in a set causing very short belt life.



## 6. PLACING THE BELTS ON THE DRIVE

Loosen motor base bolts to move the pulleys closer together to install the belts. NEVER force or roll the belts on a drive with a screwdriver or pry bar. Doing this will damage the belt internally. The belts depend on tension cables inside the belt for uniform strength and operations. Prying belts on a drive will damage one or more of these cables.

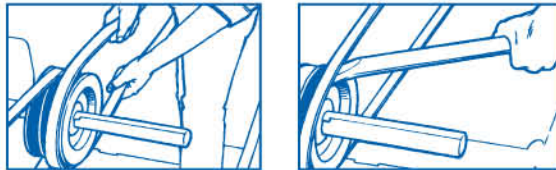

## 7. CENTER DISTANCE ALLOWANCES FOR BELT INSTALLATION AND TAKE-UP

A drive needs to be designed so that there is proper allowance for placing the belts on the drive. Suggested amounts for decrease in center distance needed for installation for various belt types are shown in the table below.

Allowance should be made for belt tension take-up over the life of the drive. A good rule of thumb is to allow 1.5% of the belt nominal length for an increase in the pulley center distance for belt take-up. (For a 100" belt length, 1.5% of 100" or an increase of 1.5" should be allowed as a minimum for belt take-up in center distance.)

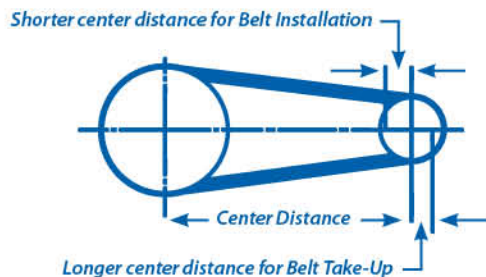

**Suggested amounts for center distance installation**

	belts up to 45"	45" to 75"	75" to 180"	180" to 300"	300" to 400"	belts over 400"
<b>Single Belts</b>						
3L	3.00	3.25	3.00	3.25	3.00	3.25
4L, A, AX	2.20	2.45	2.20	2.45	2.20	2.45
5L, B, BX	5.40	5.75	5.40	5.75	5.40	5.75
C	4.00	4.35	4.00	4.35	4.00	4.35
D	2.65	2.65	2.65	2.65	2.65	2.65
3V, 3VX	2.20	2.20	2.20	2.20	2.20	2.20
5V, 5VX	7.10	7.10	7.10	7.10	7.10	7.10
8V, 8VX	2.20	2.45	2.20	2.45	2.20	2.45
<b>Banded Belts</b>						
B	4.00	4.35	4.00	4.35	4.00	4.35
C	2.65	2.65	2.65	2.65	2.65	2.65
D	2.20	2.20	2.20	2.20	2.20	2.20
3V, 3VX	7.10	7.10	7.10	7.10	7.10	7.10
5V, 5VX	2.20	2.20	2.20	2.20	2.20	2.20
8V, 8VX	7.10	7.10	7.10	7.10	7.10	7.10

## 8. BELT DRESSING - NEVER USE IT !

A properly tensioned and installed drive WILL NEVER NEED BELT DRESSING. Belt dressing makes the surface of a belt tacky by chemically attacking and softening the rubber compounds on the surface of the belt. Doing this will rapidly accelerate the wear of the belt surface and cause extremely short belt life.



	Smallest Pulley Diameter Range	RPM Range	Belt Deflection Setting			
			uncogged belts		cogged belts	
			used belt	new belt	used belt	new belt
4L, A, AX	2.0 - 2.9	1000 - 2500	1.8	2.6	2.0	3.0
		2501 - 4000	1.4	2.0	1.6	2.4
	3.0 - 3.6	1000 - 2500	3.6	5.4	4.0	6.0
		2501 - 4000	2.8	4.1	3.3	4.9
	3.8 - 4.8	1000 - 2500	4.4	6.6	4.9	7.3
		2501 - 4000	3.7	5.7	4.3	6.4
	5.0 - 7.0	1000 - 2500	5.3	7.8	5.7	9.2
		2501 - 4000	4.6	6.8	5.1	7.6
5L, B, BX	3.4 - 4.2	860 - 2500			4.8	7.2
		2501 - 4000			4.1	6.2
	4.4 - 5.6	860 - 2500	5.2	7.9	7.1	10.5
		2501 - 4000	4.5	6.6	7.1	9.1
	5.8 - 8.6	860 - 2500	6.2	9.4	8.4	12.4
		2501 - 4000	6.0	6.8	7.3	10.7
C, CX	7.0 - 9.0	500 - 1740	11.3	17.0	14.7	21.9
		1741 - 3000	9.4	13.6	11.9	17.5
	9.5 - 16.0	500 - 1740	14.0	20.8	15.8	23.5
		1741 - 3000	12.5	18.3	14.5	21.6
D	12.0 - 16.0	200 - 850	24.7	37.1		
		851 - 1500	21.1	31.4		
	18.0 - 20.0	200 - 850	30.4	45.2		
		851 - 1500	25.6	38.0		
3V, 3VX	2.2 - 2.4	1000 - 2500			3.3	4.9
		2501 - 4000			2.9	4.3
	2.65 - 3.65	1000 - 2500	3.7	5.1	4.2	6.2
		2501 - 4000	3.0	4.5	3.8	5.6
	4.12 - 6.90	1000 - 2500	4.9	7.3	5.3	7.8
		2501 - 4000	4.3	6.6	4.8	7.3
5V, 5VX	4.4 - 6.7	500 - 1749			10	15.2
		1750 - 3000			8.9	13.2
		3001 - 4000			5.6	8.5
	7.1 - 10.9	500 - 1740	12.6	18.9	14.8	22.1
		1741 - 3000	11.2	16.5	13.7	20.1
	11.8 - 16.0	500 - 1740	15.5	23.4	17.1	25.5
1741 - 3000		14.5	21.8	16.8	25	
8V	12.5 - 17.0	200 - 850	33	49.5		
		851 - 2100	27	39.9		
	18.0 - 22.4	200 - 850	39.5	59		
		851 - 2100	35.1	52.8		
3VK	2.65 - 3.65	750 - 2500	5.6	8.3		
		2501 - 4000	4.5	6.8		
	4.12 - 6.90	1000 - 2500	7.4	11.0		
		2501 - 4000	6.5	9.7		
5VK	7.1 - 10.9	200 - 500	21.0	31.5		
		500 - 1250	18.0	27.0		
		1251 - 1900	16.8	25.2		
		1901 - 3000	16.0	24.0		
	11.8 - 16.0	200 - 740	26.6	39.9		
		741 - 1250	23.3	34.9		
8VK	12.5 - 20.0	200 - 550	44.8	67.2		
		551 - 800	39.0	58.5		
		851 - 1150	35.6	53.4		
		1151 - 2100	33.6	50.4		
	21.2 - 22.4	200 - 550	66.0	99.0		
		551 - 850	62.0	93.0		
		851 - 2100	57.5	86.3		

## optimize belt drive efficiency

To get the most from your belt drive, pay proper attention to your V-Belt tensioning and pulley size.

### Proper V-Belt Tensioning

All belts do not feel the same when properly tensioned due to different materials and tension cables used in their manufacturing processes. Therefore, one should not use "feel" to judge the correct tension of a belt. To more accurately tension V-Belt drives use the Force-Deflection Method shown below.

#### Force-Deflection Method

1. Measure the span length P.
2. At center of the span length apply a force F (using a belt tension gauge) perpendicular to the belt span, large enough to deflect the belt 1/64" for each 1" of belt span, q. So, for a 32" span, the deflection amount would be 32/64" or 1/2".
3. The force F to apply is shown, per belt, in the table to the left. NOTE: The force shown in the table is per rib. So, for a 5-rib belt, you will need to multiply the force shown in the table by five to apply to all five ribs at once.

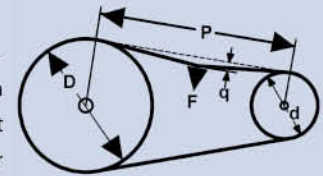

### Minimum Pulley Diameters

The successful operation of a belt drive is highly dependent on the diameter of the pulleys involved. The Rubber Manufacturers Association (RMA) has published minimum recommended pulley diameters for each belt profile. Using pulleys smaller than these recommended diameters will result in a dramatic increase in belt tension and will substantially decrease the overall belt life.

#### Minimum Recommended Pulley Diameters

Belt Type	Pitch Diameter	Outside Diameter
4L*	2.30	2.50
A	3.00	3.25
AX	2.20	2.45
B	5.40	5.75
BX	4.00	4.35
3V	2.65	2.65
3VX	2.20	2.20
5V	7.10	7.10
5VX	4.40	4.40

\*4L at this diameter has HP rating below 1/2 HP



# proper v-belt maintenance

## 1. LOOK AND LISTEN

Properly installed belts generally do not require much maintenance. V-Belt drives are recognized as extremely reliable, trouble free and efficient. The main ingredient of good maintenance of a belt drive is to look and listen. When any of the following is observed corrections can be made, and if the belts have not been damaged, then the drive will continue to perform well.

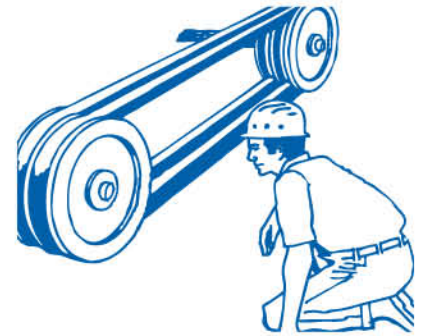

## 2. DIRT

Dirt and dust accelerate belt wear. If too much dirt accumulates in the bottom of the groove it can cause the belt to bottom out and slip.



## 3. OIL and GREASE

Belts exposed to oil in spray, liquid or paste form fail prematurely. Even belts labeled "Oil Resistant" are not designed to run in oily conditions. Oil breaks down the rubber either chemically or by causing slip, which rapidly destroys belts.



## 4. ADDED LOADS

Added loads will decrease belt life. Belt load versus belt life is not linear, so even small increases in belt loads can cause severe reduction in belt life. Doubling the load could bring belt life to 5% to 10% of the original.

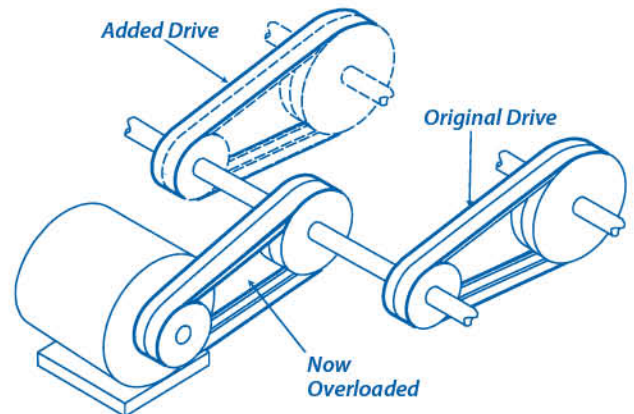

## 5. SQUEAL & CHIRP

A squeal noise is an indication of belt slip, and is most often due to insufficient belt tension. If the drive is properly tensioned, according to the table in this brochure, and the drive still and still squeals then the squeal can be due to dirt, oil, grease, misalignment, or belt overload. If the cause of the squeal is not found belt life will be dramatically reduced. A belt "chirp" sounds somewhat like that of a chirping bird and is often caused by belt

misalignment. Dust can be a contributing factor. Extremely dry or extremely wet conditions can also cause chirp. Adding belt dressing will not fix the problem, it will only destroy the surface of the belt and shorten the belt life. Chirps are often annoying, but often do not significantly shorten belt life.



## proper v-belt maintenance (cont.)

### 6. HEAT

Belts are cured in a scientifically controlled process. The rubber and other compounds in belts are adversely affected by exposure to heat, see graph below. Glazed sidewalls and cracks in belts are evidence that a belt has been

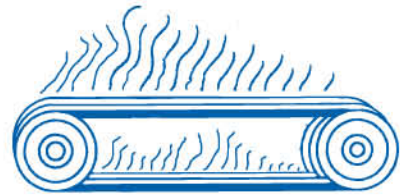

adversely affected by heat. Heat may be from higher ambient air temperature, belt slip or overload conditions.

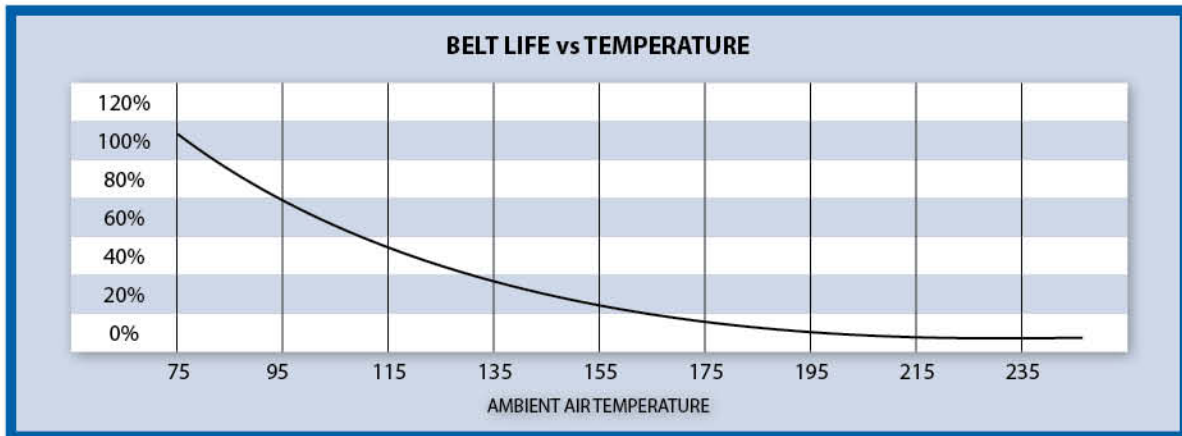

### 7. BELT TURN OVER

Belts that have rolled over indicate:

- Drive misalignment
- Worn pulleys
- Excessive vibration
- Severe pulsating loads

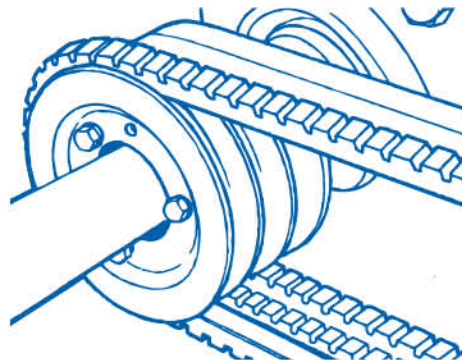

### 8. FOREIGN MATTER

The presence of foreign material can cause broken belts or excessive wear.

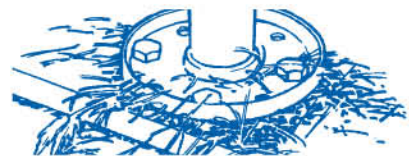

### 9. CRACKING

Bottom cracking will not reduce the tensile strength of the belt nor will it affect the operation of the belt.

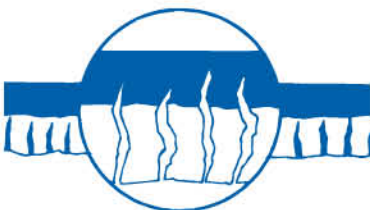

Cracking will continue fairly rapidly and indicates a belt should be changed.

The presence of many cracks all the way around the belt indicates the belt should be changed soon. High temperatures, dust, small diameter pulleys and backside idlers accelerate cracking.

### 10. TENSIONING

If you observe slip, vibration or squeal sounds then the drive should be retensioned according to the tensioning directions in the installation section of this manual.



### 11. BELT DRESSING

As stated in the belt installation notes, NEVER use belt dressing of any kind. Belt dressing chemically attacks the surface of the belt to make it tacky and dramatically reduces belt life.



### 12. BELT AND / OR PULLEY WEAR

If the belts are riding significantly different than the correct position there is a drive problem to correct. Sheave wear, dust, dirt, misalignment, rough sheave grooves, slip, overloading and debris are common problems.



Correct



Sheave wear, dust or dirt



Misalignment



Belt wear  
rough grooves, slip, overload

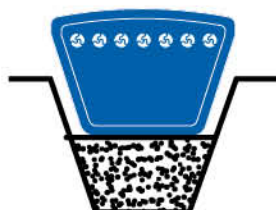

Debris

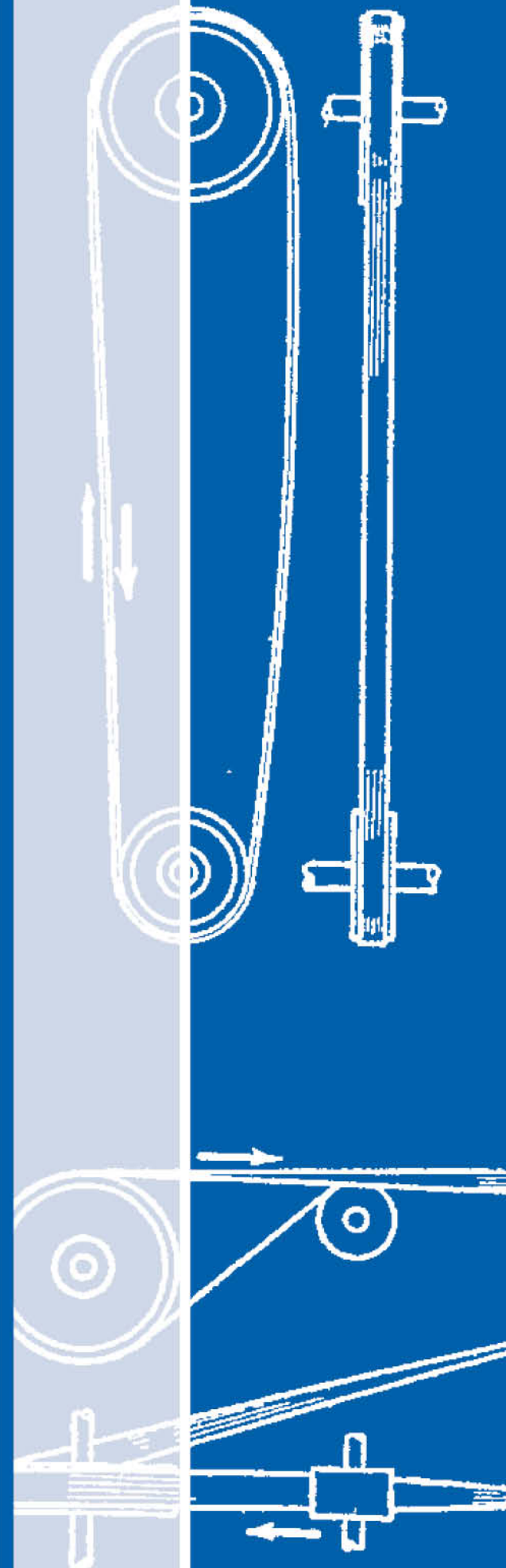

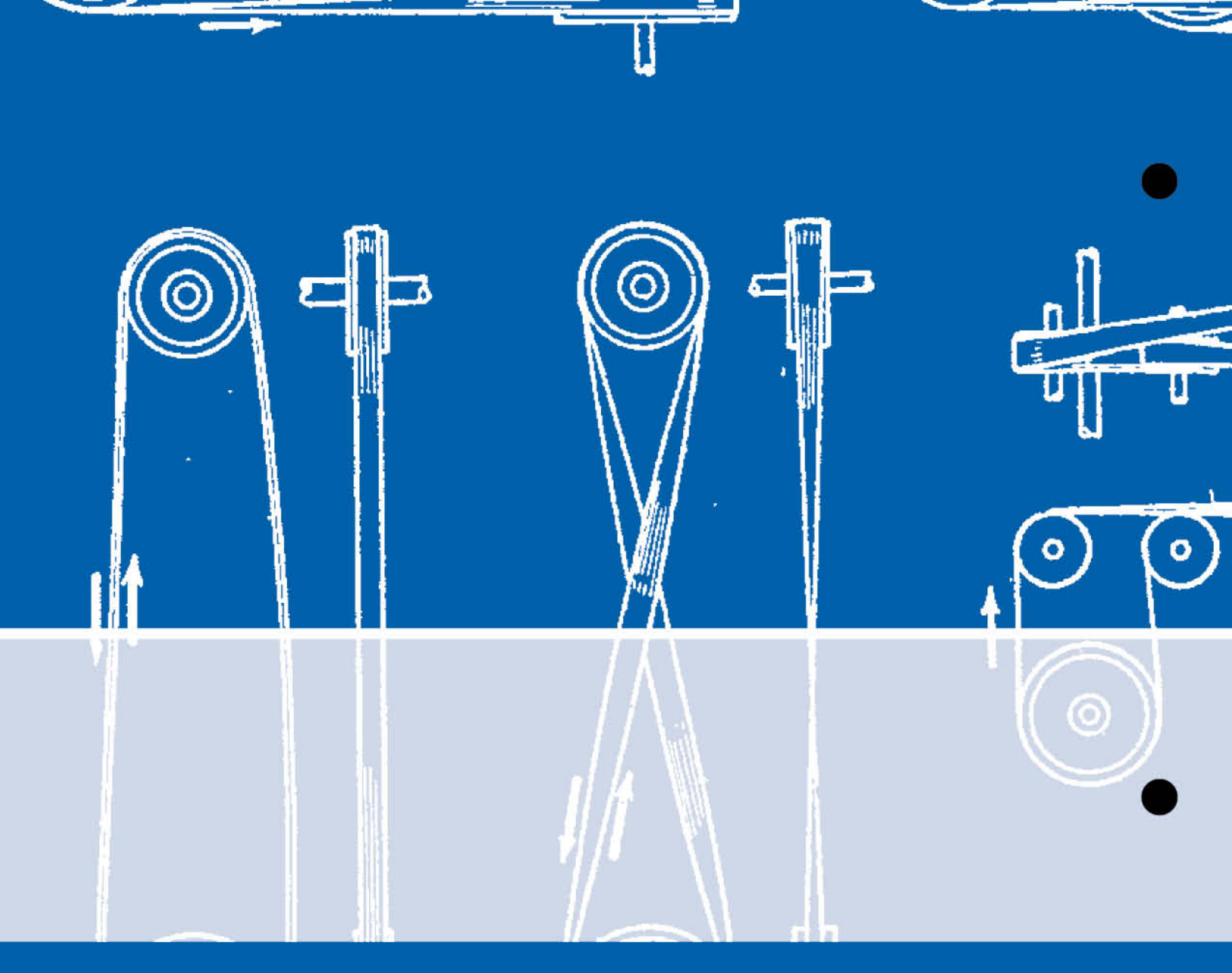

**BESTORQ**<sup>®</sup>

ph 877.773.9966

fx 877.329.8416

orders@bestorq.com

bestorq.com

your local distributor: